

SL Security Luminaire

Induction



Features



Wattage: 70-100W

Lamp: Round Tubular (RT) or Ball Type (VL)

Lamp Life Rating: 100,000 hours

Lumen Maintenance: $\geq 70\%$ at 60,000 hours

Ballast: Ballast

IP Rating: IP55

Installation: Round Pole

Ambient Temperature: -20 to +40°C (-4 to 104°F) *Tolerance of -40°C available upon request

Warranty: 10 years (see warranty for details)

Description

- High pressure die cast aluminum alloy casing for corrosion and durability
- Heat resistant acrylic hood with beautiful contour and low glare lighting
- Intelligent infrared sensor
- Photocell comes standard to maximize energy conservation
- Induction lamp features high lighting efficacy, long lifetime, good color rendering and stable light output
- Electronic ballast features high power factor and flicker-free operation
- Applications: Roadways, buildings, gardens, streets, etc.

Induction Lamp Specifications

CCT: 5000K (2720-6500K available by order)
CRI: ≥ 80
Operating Frequency: 100-300 KHz
Lumen Maintenance: $\geq 70\%$ at 60,000 hours
Rated Life: 100,000 hours

Electronic Ballast Specifications

Voltage: 120-277V
Power Factor: ≥ 0.95
Input Frequency: 50/60 Hz
THD: <10%
Case Temperature: <65°C (149 °F)

Lamp Type	Wattage (W)	Rated Lumens (Lm)	Efficacy (Lm/W)	Input Power (W)	Input Current (A)
RT	40	2800-3000	70-75	42	0.35-0.15
RT	70	4900-5250	70-75	74	0.61-0.27
RT	80	6000-6400	75-80	84	0.70-0.30
RT	100	7500-8000	75-80	105	0.88-0.38
VL	35	2450-2625	70-75	37	0.31-0.13
VL	55	4125-4380	75-80	58	0.48-0.21
VL	85	6375-6800	75-80	89	0.74-0.32

Dimensions

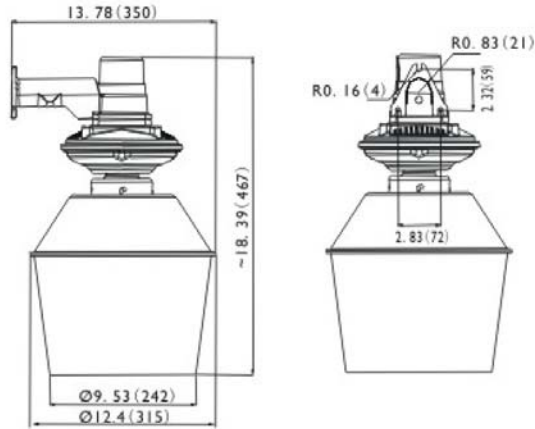

Photometric Data

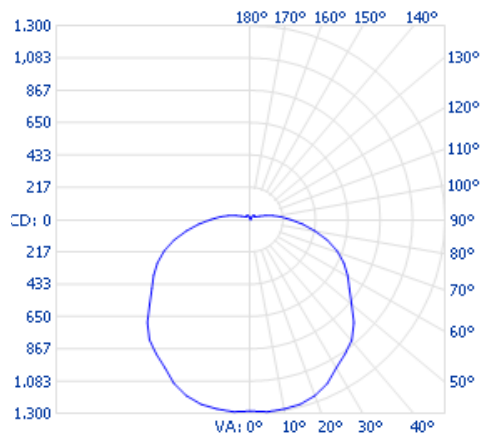

RT100W

Ordering Information

example: NV-SL-RT80W

NV	-	[Fixture]	-	[Lamp]	-	[Optional Accessories]
		SL		RT40W		LS - Light Sensor/Photocell
				RT70W		OS - Occupancy/Motion Sensor
				RT80W		WR - Wireless Remote Control System
				RT100W		AC - 0-10V Analog Control
				VL35W		DC - Wall Pack Digital Control
				VL55W		TC - Timing Control
				VL85W		

Installation Instructions

1. Remove the two teathed hexagon screws from the round plate and connect the inserts between hood and gear box firmly

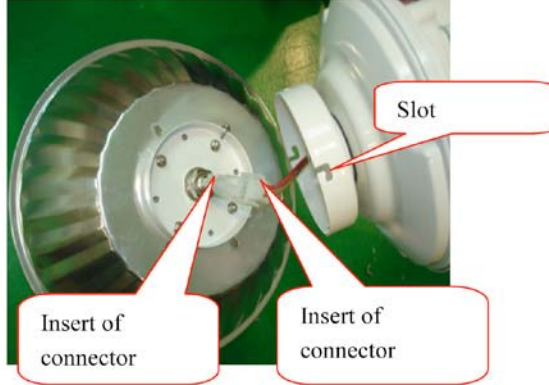

2. Align the 4 holes in the connector of gear box and the hood and secure it with teathed hexagon screws

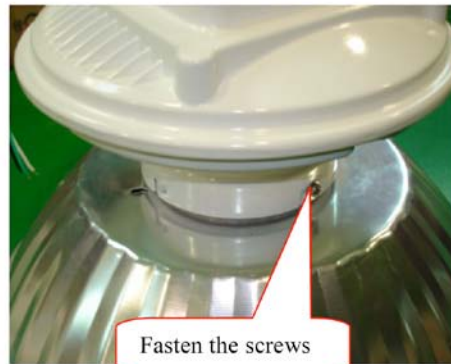
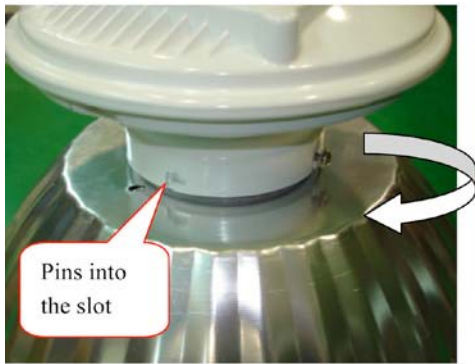

Wiring Instructions

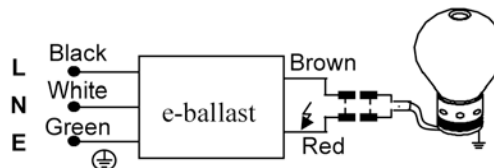
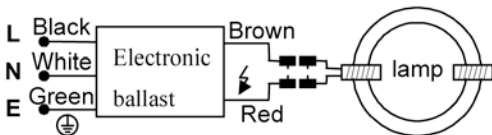

NOTE: Efficient and reliable grounding is necessary for personal safety and the proper use and operation of the electronic ballast to meet EMC standards without interference to the equipment. Do not use this luminaire without proper grounding.

Important Safety Information:

1. This fixture must be installed in an area with good ventilation, no corrosive gases, and no combustible or explosive objects.
2. The supply voltage can vary by +20% and -18%. It will affect the operation of the lamp and damage the electronic ballast if it is outside of this range.
3. Maintenance should be done only after the power is cut off and the lamp has cooled down.
4. A three-core cable conductor is the best input lead of power supply. The insulation maximum temperature of the cable conductor should be 105°C (221°F).
5. Do not open the fixture cover or remove the lamp while the product is in use or the power is on.
6. This product should be installed and serviced by a certified electrician.

Warranty:

Nu Vue Lighting, LLC (Nu Vue) warrants that the induction lamp system shall be free from defect in material and workmanship for 10 years or 60,000 hours, whichever comes first when operated according to the conditions listed below. Warranty coverage period begins from original invoice date, if the original invoice cannot be found the warranty coverage begins from manufacture date (stamped on the electronic ballast and lamp tube).

Warranty Conditions:**Temperature Conditions:**

Induction lamp and ballast system (not including fixture): Maximum case temperature of the electronic ballast must be less than 65°C (149°F)

Induction lamp and ballast system (including fixture): Ambient temperature (where the induction lamp system is to be operating) must not exceed 40°C (104°F).

The temperatures stated above shall be determined by installing the induction lamp system in the field condition. After installation, if testing shows that the temperatures do not exceed the conditions described above, Nu Vue shall have the sole discretion to repair any parts of the product or to replace any defective induction lamp system free of charge to the place of original installation (provided that it is covered under the terms and conditions of this limited warranty). Please see full warranty for temperature check points. If Nu Vue replaced any defective product with new product the warranty coverage is from the original invoice date; not the replacement date. Any simulated field condition test concerning any induction lamp system which is claimed to be defective must be mutually agreed upon in writing. Nu Vue holds the right of being notified of and present at any such tests.

This limited warranty is only valid if the original purchaser or end user completes and submits a registration card with specific installation information within 30 days of product install. This constitutes the complete warranty for Nu Vue induction lamp systems and fixtures, unless other terms and conditions are established and agreed upon by both parties, in which case further documentation must be presented.

Nu Vue does not warrant the installation, maintenance, or service of induction lamp systems and fixtures. Nu Vue is not responsible for any ancillary equipment that was not provided by Nu Vue, which is attached to or used in connection with the induction lamp systems and fixtures, or for the operation of the induction lamps and fixtures with any ancillary equipment. All such equipment is to be excluded from this limited warranty. Further, Nu Vue shall not be responsible for any damage to the induction lamp systems and/or fixtures resulting from the use of any ancillary equipment with the induction lamp systems and fixtures.

If a retrofit kit (ballast and lamp only) is to have a valid 5 year warranty, a Retrofit Assessment Form must be submitted and approved by Nu Vue. If Nu Vue does not approve of the specifications of the retrofit project the warranty is either voided or Nu Vue will honor a shorter warranty period that is assigned to the specific project.

What The Warranty Does Not Cover

This limited warranty is contingent upon the proper storage, installation, use and maintenance of the induction lamp systems and fixtures, as well as accordance with any further recommendations from Nu Vue. This limited warranty is not applicable to any induction lamp system that has been subjected to abnormal stresses and operating conditions such as temperatures in excess of maximum rated temperatures, under/over voltage, excessive switching cycles or operating hours or is not installed in accordance with Nu Vue's application guidelines and instructions. Nu Vue also will not cover any profile aluminum ballasts that were installed in existing High/Low Bay ballast compartments.

How to Obtain Warranty Service

If it appears that an installed induction lamp system and/or fixture does not meet the limited warranty set forth above, within the time periods stated above, the purchaser shall notify Nu Vue and make a warranty claim by calling 1-866-996-8883. After receiving proper authorization from Nu Vue, the defective induction lamp system and/or fixtures should be returned to the place of original purchase, unless otherwise directed by Nu Vue. If replacement parts or products are issued, clients have 14 days to return defective material upon receipt of replacement items. If defective material is not returned in the set time frame, a new invoice will be issued for the cost of replacement product.

General Provisions

This limited warranty sets forth the entirety of Nu Vue's responsibilities regarding the induction lamp systems and fixtures. Complete compensation for a defective induction lamp system and/or fixture consists only of the replacement of the defective lamp system and/or fixture. Limitations of liability: under no circumstances, whether as a result of breach of contract, breach of warranty, tort, strict liability or otherwise, will NU VUE be liable for consequential, incidental, special or exemplary damages, including but not limited to, loss of profits, loss of use or damage to any property or equipment, cost of capital, cost of substitute product, facilities or services, down time costs, or claims of claimant's customers. Nu Vue's liability for claims of any kind or for any loss or damages arising out of, resulting from or concerning any aspect of this warranty or from the induction products or services furnished hereunder, shall not exceed the price of the specific induction lamp system and the fixture products which gives right to the claim. IN NO EVENT SHALL NU VUE BE LIABLE FOR DAMAGES IN EXCESS OF THE PURCHASE PRICE OF THE INDUCTION LAMP SYSTEM, FOR ANY LOSS OF USE, LOSS OF TIME, INCONVENIENCE, COMMERCIAL LOSS, LOST PROFITS OR SAVINGS OR OTHER INCIDENTAL, SPECIAL OR CONSEQUENTIAL DAMAGES ARISING OUT OF THE USE OR INABILITY TO USE SUCH INDUCTION LAMP SYSTEM AND THE FIXTURE TO THE FULL EXTENT THAT SUCH MAY BE DISCLAIMED BY LAW.